



Collezione 2025



**CIÖCC**





**2025**





## La spinta di un sogno The push of a dream

Quando il sogno cede all'esigenza di misurarsi con la natura quasi illimitata, nasce nell'uomo il desiderio di costruire. Ed è seguendo questo desiderio di andare oltre i confini che gli uomini delle Italian Style Bicycles trasformano ogni giorno la passione nell'alta qualità delle loro biciclette. Un risultato che è frutto di un vero e proprio lavoro artigianale e di una spinta che regala all'uomo il gusto di vincere.

When the dream gives way to the desire to measure oneself against the limitless nature, people desire to create... following this wish the people of Italian Style Bicycles turn passion into high quality of their bicycles every day. A result that is the effect of a accurate craftsmanship, that gives to the rider the taste of efficiency and exclusivity.

## Qualità frutto della tradizione Quality through tradition

Ciöcc nasce all'inizio degli anni 70 e da allora comincia la sua crescita e affermazione a livello internazionale ottenendo importanti risultati. Negli anni '80 Ciöcc era un'azienda senza uguali in Europa per la produzione di telai da corsa di alto livello. In quegli anni usarono biciclette Ciöcc alcuni nomi noti del ciclismo nazionale e internazionale. Ciöcc è stata capace di adeguarsi ai cambiamenti radicali che hanno investito il mondo della bicicletta a partire dagli anni '90. Cambiamenti che hanno visto pian piano ridursi l'uso del classico telaio in acciaio a favore di prodotti in alluminio prima e carbonio poi.

For fans of cycling and road bike, Ciöcc is a brand that recalls the beginnings of tradition of the artisan Italian frame. During the 60s Italy is characterized for the birth of several workshops, competing each other to create the best bike. These will then become the brands we all know that would bring the Italian bike to be the most appreciated worldwide. The current manufacturing process is fully manual and it follows the simple techniques of the past: after being cut and shaped with special tools tubes are prepared and assembled with a template giving birth to the frame. Ciöcc was able to adapt his craftsman philosophy to the changes that have affected the world of cycling since the early 90s. Once assembled the frame we go to a stage where the craftsmanship gives its added value. We are talking about the "wrapping" of the frame, which allows you to "weld" the tubes and make the frame efficient and safe. The yarn of carbon fiber based on its density, determines stiffness, comfort and strength.





## Tecnologia / Technology

Ogni nuovo modello Ciocc è progettato mediante l'uso di sofisticati software che permettono la "visualizzazione" del telaio in 3D. Ultimata la fase di ideazione i progetti passano alla fase di costruzione degli stampi per creare tubi personalizzati e a sua volta messi in autoclave. Tutti i passaggi sono rigorosamente manuali. La tecnica di assemblaggio tutta manuale segue ancora le tecniche semplici di una volta: preparati i tubi vengono assemblati in dima dopo essere stati tagliati e sgolati con attrezzature speciali formando il telaio. Una volta assemblato il telaio si passa ad una fase dove l'artigianalità dà il suo valore aggiunto ed è la fasciatura del telaio, la quale permette di "saldare" i tubi e rendere il telaio performante e sicuro. Il filato della fibra di carbonio in base alla sua densità lineare determina rigidità, comfort e resistenza. Dopo un accurato studio grafico la verniciatura richiede molte più ore di lavorazione rispetto ad uno standard. Occorre realizzare ad hoc tagli e mascherine per creare un design particolare ed unico.

Each new model Ciocc is designed through sophisticated software that allow the "display" of the frame 3D. Once the design phase is complete the project goes to the construction of the molds to create customized tubing. All steps are strictly hand made. The current manufacturing process is fully manual and it follows the simple techniques of the past: after being cut and shaped with special tools tubes are prepared and assembled with a template giving birth to the frame. Once assembled the frame we go to a stage where the craftsmanship gives its added value. We are talking about the "wrapping" of the frame, which allows you to "weld" the tubes and make the frame efficient and safe. The yarn of carbon fiber based on its density, determines stiffness, comfort and strength. After a careful graphic study the painting requires much more hours compared to a standard process with water decals. The handmade liquid painting, needs the preparation of specific template and cuts in order to create a special and unique design.



  
**CIÖCC**



# Sommario

## Index

### Road

SUPREMO	10
DEVILRY RACE	14
BLADE PRO	18
RYDON	24
MISFIT	28
PRO RACE	32

### Gravel

FALCON CX	38
OUTBACK CX	42
MISFIT CX	46
PRO RACE CX	50

### Vintage

REPLICA	58
SAN CRISTOBAL 77	60

### Tandem

TANDEM CARBON	64
TANDEM ALUMINIUM	66

### Electric

<b>ROAD</b>	
E-SUPREMO	70
THOR EVO 6.0	74
E-VELOCE	78
B-POWER 1000	104

<b>GRAVEL</b>	
E-XTRO CX	82
E-THOR CX	86
E-THOR URBAN	90
E-XPLORER CX	92
E-XPLORER URBAN	96
E-LADY URBAN	98
B-POWER 1000 CX	104

<b>MOUNTAIN BIKE</b>	
BLAZE CARBON 880	100

<b>TANDEM</b>	
B-POWER GRAVEL	108
B-POWER MTB	110





# Road Bikes

NEVERENDING PASSION





# Supremo

CARBON



## Eleganza minimale per una bicicletta unica.

Minimalist elegance  
for a unique bicycle.

Telaio di alta gamma ideale per amatori e gare granfondo. Realizzato con finitura carbonio 3K, la trama esistente più fine e performante per ottimizzare pesi e caratteristiche; rigido e confortevole è particolarmente consigliato per le lunghe distanze e salite impegnative, ma rimane un telaio versatile da utilizzare su tutti i tipi di percorso.

Top range frame ideal for amateurs and granfondo races. Made with carbon finish 3K that is the finest fibers available, offering the best performance to optimize weights and mechanical characteristics. Thanks to its grade of rigidity and comfort is very recommended for long distances and challenging climbs, but it remains a versatile frame to be used on all types of path.

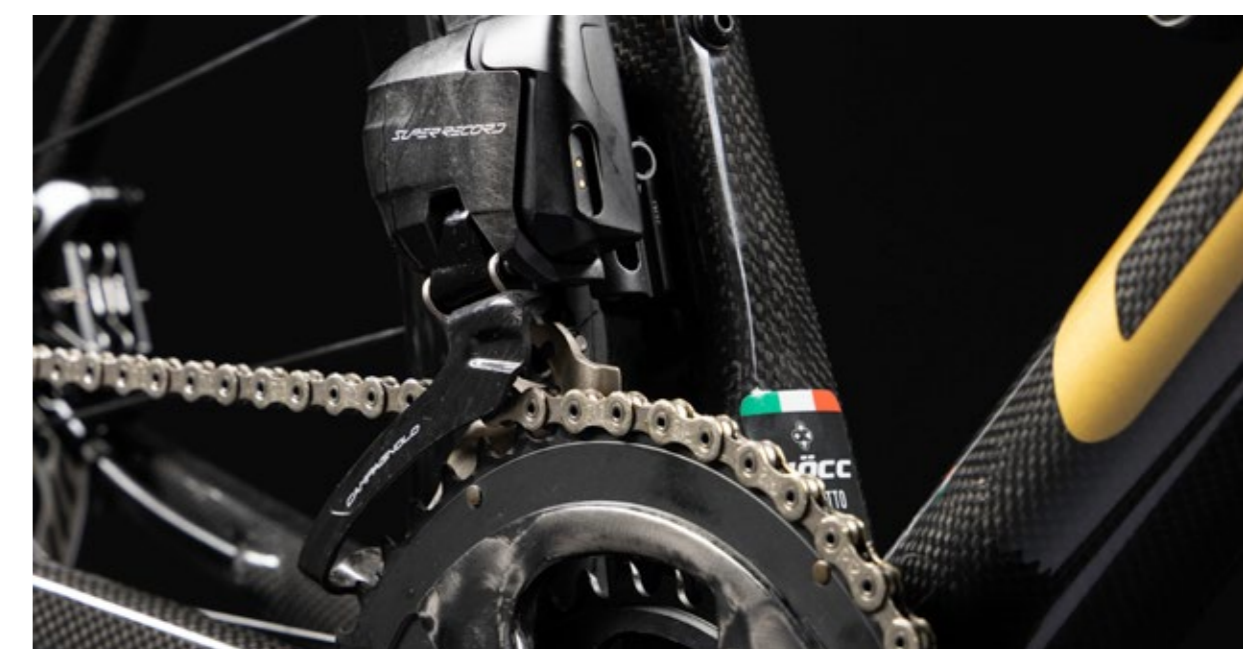



# Supremo

## Tech

telaio carbonio fasciato T600 3K carbon	carbon wrapped frame tube-to-tube
laminazione esterna dialed K1352U SHM combinata con M46J	outer lamination carbon 3K
sterzo D 56 integrato (dcr system) valore rigidità 115 n/mm	head tube 56 mm o.d. - full integrated cable routing stiffness valeu 115 n/mm
forcella 3K CARBON FKT DCR 1.5"	3K CARBON FKT DCR 1.5"
sterzo FSA HS NO 55R 1,5A SR/STD	FSA HS NO 55R 1,5A SR/STD
reggisella diametro 27,2mm	seatpost diam: 27,2 mm
copertoncini max 28c	max tires acceptance 700 x 28c
passante anteriore 12 /100 mm	axle 12/100 mm
passante posteriore 12/142 mm (su richiesta UDH)	axel 12/142 mm (on request UDH)
movimento centrale diametro 86 x 41,5	press fit bottom bracket press fit 86 x 41,5
<b>peso telaio 790 g (misura m)</b>	<b>frame weight 790 g (size m)</b>

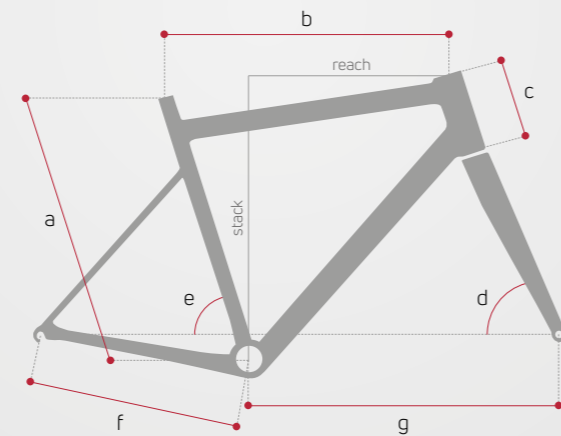

## Geometrie

size	a	b	c	d	e	f	g	stack	reach
<b>xs</b>	430	510	110	70,5°	75°	400	580	502,96	372,8
<b>s</b>	460	525	130	71,3°	74,5°	402	580	524,67	377,76
<b>m</b>	490	535	145	71,75°	73,5°	402	585	540,48	378,79
<b>l</b>	520	555	160	73°	73,5°	404	585	559,13	389,1
<b>xl</b>	540	565	170	73°	73°	407	590	569,82	390,97
<b>xxl</b>	560	575	190	73°	72,5°	410	600	587,82	390,94
<b>xxxl</b>	580	590	205	73°	72°	410	600	603,26	394,71

\* su richiesta telaio su misura / customized frame on request





# Devilry Race ROAD

CARBON



## Design aerodinamico e reggisella in carbonio integrato nel telaio.

Aerodynamic design and Aero carbon seatpost.

Telaio di alta gamma ideale per amatori e gare granfondo. Realizzato con finitura carbonio 3K, la trama esistente più fine e performante per ottimizzare pesi e caratteristiche; grazie alle sue caratteristiche di rigidità e confort è particolarmente consigliato per le lunghe distanze e salite impegnative, ma rimane un telaio versatile da utilizzare su tutti i tipi di percorso. Un Devilry Race montato con gruppi a freno disco Idraulico.

Hand made carbon frame for riders who prefer the speed and quickness- a very responsive frame but able to offer the characteristics of the typical comfortable carbon frame that makes it suitable for long runs and granfondo races. The shaped seat tube gives a racing geometry- rigidity and strength are characteristics you can feel since the first ride. A Devilry Race with hydraulic brakes set.





# Devilry Race

## Tech

telaio carbonio fasciato t600	carbon wrapped frame tube-to-tube
laminazione esterna dialed K1352U SHM combinata con M46J	outer lamination carbon 3k
sterzo D 56 integrato (dcr system) valore rigidità 115 n/mm	head tube 56 mm o.d. - full integrated cable routing-stiffness valeu 115 n/mm
forcella 3k carbon FKT DCR 1.5"	3k carbon FKT DCR 1.5"
sterzo FSA HS NO 55R 1,5A SR/STD ACR	FSA HS NO 55R 1,5A SR/STD ACR
reggisella sl aero 3k	seatpost sl aero 3k
copertoncini max 30c	max tires acceptance 30c
passante anteriore 12 /100 mm	axle 12/100 mm
passante posteriore 12/142 mm (su richiesta UDH)	axle 12/142 mm (on request UDH)
movimento centrale diametro 86 x 41,5 press fit	bottom bracket press fit 86 x 41,5
<b>peso telaio 820 g (misura m)</b>	<b>frame weight 820 g (size m)</b>

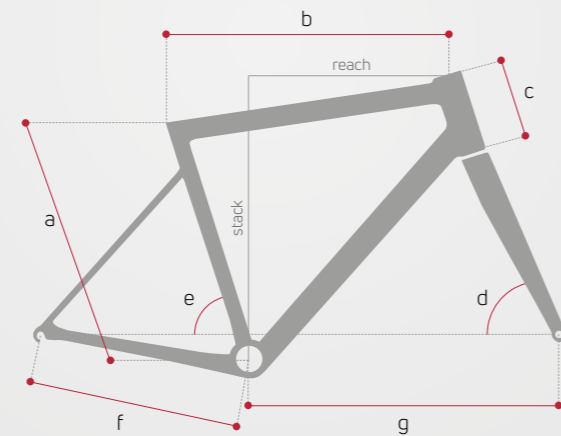

## Geometrie

size	a	b	c	d	e	f	g	stack	reach
<b>xs</b>	430	510	110	70,5°	75°	400	580	502,96	372,8
<b>s</b>	460	525	130	71,3°	74,5°	402	580	524,67	377,76
<b>m</b>	490	535	145	71,75°	73,5°	402	585	540,48	378,79
<b>l</b>	520	555	160	73°	73,5°	404	585	559,13	389,1
<b>xl</b>	540	565	170	73°	73°	407	590	569,82	390,97
<b>xxl</b>	560	575	190	73°	72,5°	410	600	587,82	390,94
<b>xxxl</b>	580	590	205	73°	72°	410	600	603,26	394,71

\* su richiesta telaio su misura / customized frame on request







# BLADE PRO

LIMITED EDITION



Chromo ULTRA





# Blade Pro ROAD

CARBON



## Un gioiello di tecnologia ed innovazione.

When the steel frame is renewed and weight almost like carbon.

Pensata per offrire il massimo delle performance. Progettata per esaltare la trasmissione della potenza dai pedali al terreno offrendo allo stesso tempo reattività e precisione di guida ad ogni velocità. Grazie ai nuovi forcellini posteriori rinforzati per il bloccaggio delle ruote, ad un triangolo posteriore ribassato, al monoscocca del telaio caratterizzato da tubazioni dalle linee rigide ed aerodinamiche, è l'arma vincente per contrastare al meglio la forza centrifuga in curva e la resistenza all'avanzamento negli sprint.

The "Blade" is a gem of technology and innovation. Designed to provide maximum performance. Designed to enhance the power transmission from pedals to the ground and to give a responsive and precise steering at all speeds and on every type of track. New rear dropouts reinforced for the locking of the wheel, a lower rear triangle, a monocoque frame with aerodynamic and stiff tubing are innovative characteristics of this model.





# Blade PRO

## Tech

telaio carbonio monoscocca	frame carbon monocoque
laminazione UDM / INT. M40J	UDM carbon fibers / INT. M40J
sterzo D 56 integrato (acr system)	head tube 56 mm o.d. - (acr system)
forcella full carbon integrale system DCR D56	dcr full carbon integrated system DCR D56
sterzo FSA HS NO 55R 1,5A SR/STD	FSA HS NO 55R 1,5A SR/STD
reggisella incluso sl aero	dedicated carbon seat post aero sl
copertoncini max 28c	max tires acceptance 28c
perno passante anteriore 12/100 mm	axle 12/100 mm
perno passante posteriore 12/142 mm	axle 12/142 mm
movimento centrale diametro 86 x 41 press fit	bottom bracket press fit 86 x 41,5
<b>peso telaio 1.050 g (misura 50)</b>	<b>frame weight 1.050 gr (size 50)</b>

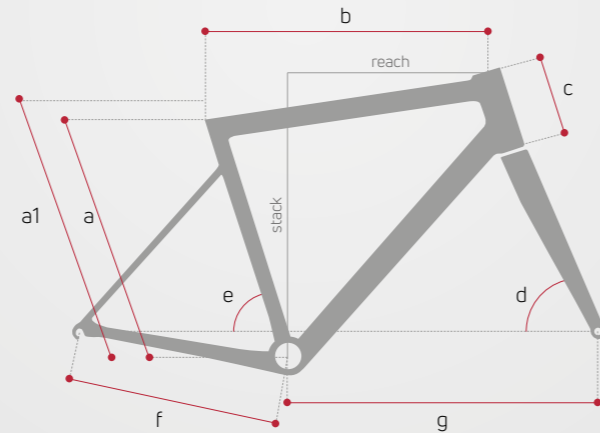

## Geometrie

size	a1	a	b	c	d	e	f	g	stack	reach
<b>s</b>	490	460	510	105	71,5°	75°	406	573	515	373
<b>m</b>	520	480	531	115	72,5°	74°	406	575	527	380
<b>l</b>	540	495	541	135	73°	74°	406	581	547	384
<b>xl</b>	560	520	562	155	73,5°	73,5°	406	593	568	394
<b>xxl</b>	580	540	580	180	73,5°	73,5°	406	607	592	403

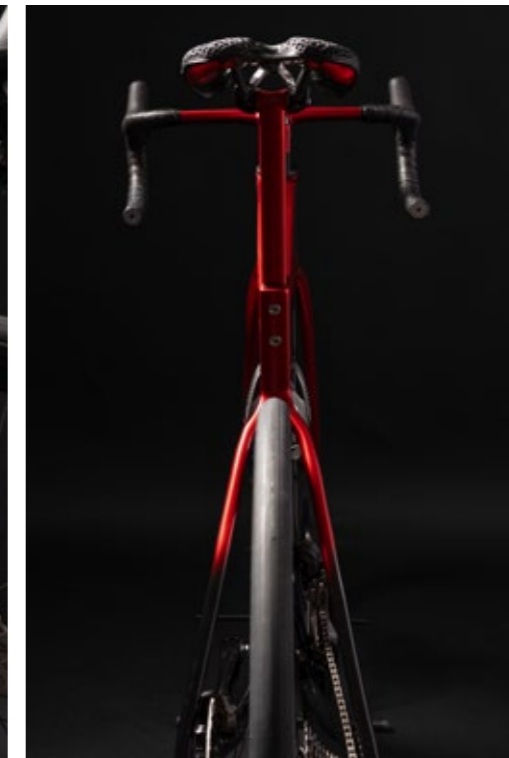
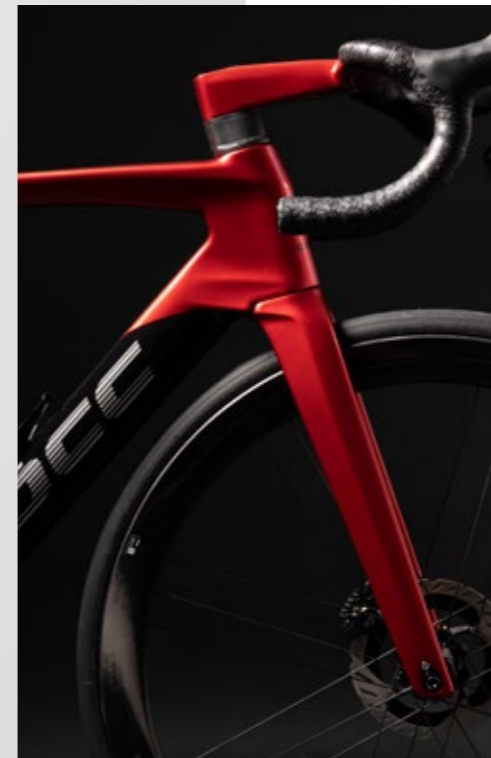



# Rydon SL ENDURANCE

CARBON



## Forma unica, concentrato di tecnologia.

A unique shape, paked with technology.

Il telaio Rydon è pensato per accompagnare ciclisti amanti delle lunghe distanze, che non vogliono rinunciare alla comodità nè alle prestazioni. I telai sono in fibra di carbonio UDM, tecnologia che permette una minor vibrazione e un maggior confort su percorsi lunghi.

The Rydon frame is designed to satisfy long-distance riders, who do not want to renounce either to comfort or performances. The frames are made of UDM carbon fiber, this technology reduce vibrations and increase comfort on long distance.





# Rydon SL

## Tech

telaio carbonio monoscocca	frame carbon monocoque
laminazione UDM / int. M40J	udm carbon fibers - int. M40J
sterzo D 56 integrato (dcr system)	head tube 56 mm - full int. cable routing
forcella full carbon integrale system DCR D56	full carbon integrated system DCR D56
sterzo FSA HS NO 55R 1,5A SR/STD DCR	FSA HS NO 55R 1,5A SR/STD DCR
reggisella Ø 27,2 mm	seat post Ø 27,2 mm
passaggio ruota copertoncini max 34c	max tires acceptance 34c
perno passante anteriore 12/100 mm	axle 12/100 mm
perno passante posteriore 12/142 mm	axle 12/142 mm
movimento centrale diametro 86 x 41 press fit	bottom bracket press fit 86 x 41,5
<b>peso telaio 950 g</b>	<b>frame weight 950 g</b>

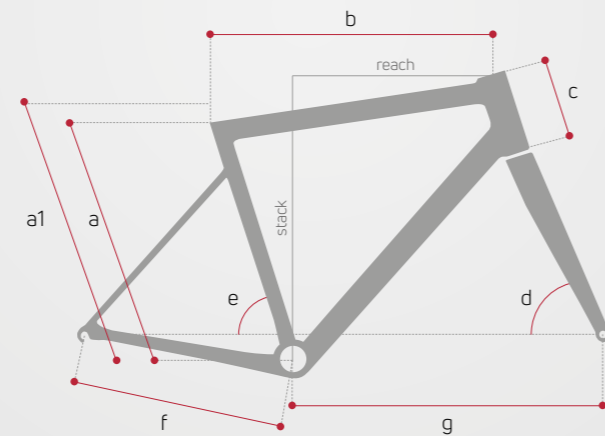

## Geometrie

size	a1	b	c	d	e	f	g	stack	reach
<b>s</b>	490	520	143,2	71°	75°	425	589,1	534,3	376,8
<b>m</b>	520	535	158,6	71,5°	74°	425	590,5	553	376,1
<b>l</b>	540	545	167,2	72°	73,5°	425	591,3	564,5	377,8
<b>xl</b>	560	560	178,4	72°	73°	425	601,2	583,5	381,6
<b>xxl</b>	580	575	184,2	72°	73°	425	616,5	602,5	390,8





# Misfit ROAD

TITANIO



## Confort ed efficacia. Comfort and efficiency.

Si dice "il titanio è per sempre" e i nostri telai ne sono la conferma; la resistenza alla corrosione e le caratteristiche meccaniche ne fanno di una bici da sogno eterna. Il telaio MISFIT si distingue per una resa nel tempo invidiabile accompagnato da un buon peso e ottima comodità che ne fanno un modello da granturismo per eccellenza.

They say "titanium is forever" and our frames are the confirmation; the resistance to corrosion and the mechanical characteristics make it an eternal dream bike. The MISFIT frame stands out for its enviable performance over time accompanied by a good weight and excellent comfort which make it a touring model par excellence.







# Misfit Titanium

## Tech

telaio titanio GRADE 9 (3/AL - "5V)	grade 9 titanium frame (3/AL - 5V)
forcella 3K CARBON FKT DCR 1.5"	3K CARBON FKT DCR 1.5"
sterzo D 56 integrato (acr/dcr system)	head tube 56 mm - full int. cable routing
reggisella 27,2 mm	seatpost diam: 27,2 mm
passaggio ruota copertoncini 30	max tires acceptance 30
perno passante anteriore 12/100 mm	front through-axle 12/100 mm
perno passante posteriore 12/142 mm	rear through-axle 12/142 mm
movimento centrale 86x41 (su richiesta T47)	bottom bracket press 86x41 (on request T47)
<b>peso telaio 1.300 g (misura m)</b>	<b>frame weight 1.300 g (size m)</b>

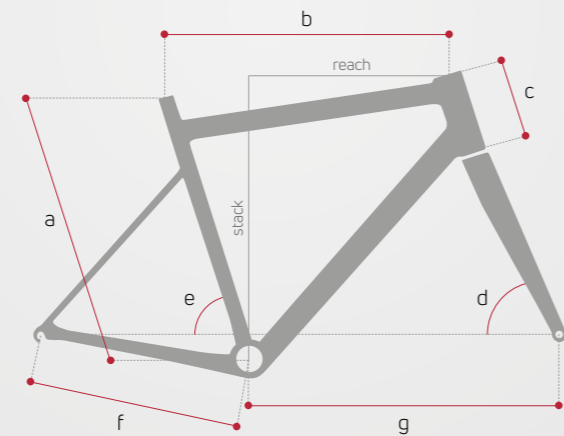

## Geometrie

size	a	b	c	d	e	f	g	stack	reach
<b>xs</b>	430	510	110	70,50°	75°	400	58	502,96	372,8
<b>s</b>	460	525	130	71,30°	74,5°	402	58	524,67	377,76
<b>m</b>	490	535	145	71,75°	73,5°	402	58,5	540,48	378,79
<b>l</b>	520	555	160	73°	73,5°	404	58,5	559,13	389,1
<b>xl</b>	540	565	170	73°	73°	407	59	569,82	390,97
<b>xxl</b>	560	575	190	73°	72,5°	410	60	587,82	390,94
<b>xxxl</b>	580	590	205	73°	72°	410	60	60,326	394,71

\* su richiesta telaio su misura / customized frame on request



\* su richiesta anche in versione gravel / on request also in gravel version





# Pro Race ROAD

ACCIAIO



## Comfort ed efficacia. Comfort and effectiveness.

Si dice "l'acciaio è per sempre" e i nostri telai ne sono la conferma; la resistenza alla corrosione e le caratteristiche meccaniche ne fanno una bici da sogno eterno. Il telaio pro race Disc si distingue per una resa nel tempo invidiabile accompagnato da un buon peso e ottima comodità che ne fanno un modello da granturismo per eccellenza.

"Steel is forever" and our frames are the confirmation; corrosion resistance and mechanical properties make this dream bike eternal. The frame Pro Race Disc stands out for an enviable performance over the time accompanied by a light weight and excellent







# Pro Race

## Tech

telaio acciaio spirit columbus HSS	steel tubing columbus sl spirit HSS welded
OMNICROM	OMNICROM
forcella DEDA EDG D-Shape DCR POB	fork DEDA EDG D-Shape DCR POB
sterzo 56 mm 1/2	head tube o.d. 56 mm 1/2
reggisella 27,2 diam.	seatpost diam: 27,2 mm
copertoncini max 28c	max tires acceptance 28c
perno passante anteriore 12/100 mm	axle 12/100 mm
perno passante posteriore 12/142 mm	axle 12/142 mm
press fit BB86x41 (su richiesta T47)	press fit BB86x41 (option T47)
<b>peso telaio 1.590 g (misura m)</b>	<b>frame weight 1.590 g (size m)</b>

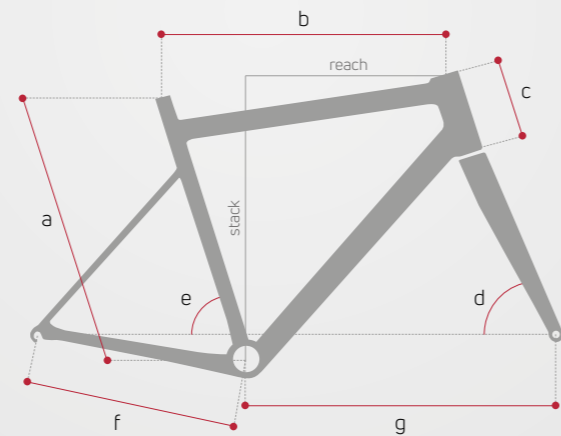

## Geometrie

size	a	b	c	d	e	f	g	stack	reach
xs	430	510	110	70,50°	75°	400	58	502,96	372,8
s	460	525	130	71,30°	74,5°	402	58	524,67	377,76
m	490	535	145	71,75°	73,5°	402	58,5	540,48	378,79
l	520	555	160	73°	73,5°	404	58,5	559,13	389,1
xl	540	565	170	73°	73°	407	59	569,82	390,97
xxl	560	575	190	73°	72,5°	410	60	587,82	390,94
xxxl	580	590	205	73°	72°	410	60	60,326	394,71

\* su richiesta telaio su misura / customized frame on request







# Gravel Bikes

NEVERENDING ADVENTURES





# Falcon CX

CARBON



## Ridefinisce Le Prestazioni. That Redefines the Game.

La Falcon è la bicicletta gravel che incarna il massimo delle prestazioni su ogni terreno. Grazie al telaio in carbonio ultraleggero e progettato per massimizzare la potenza, Falcon offre una rigidità e una reattività eccezionali, adattandosi perfettamente sia alle sfide del fuoristrada che alle lunghe distanze. Con la sua geometria all'avanguardia e una struttura performante, Falcon si distingue come la migliore della sua classe, pronta a trasformare ogni pedalata in un'esperienza unica.

The Falcon is the ultimate gravel bike, delivering top performance on any terrain. With its ultra-light carbon frame designed to maximize power, the Falcon offers exceptional stiffness and responsiveness, making it perfect for both off-road challenges and long-distance rides. Featuring cutting-edge geometry and a performance-oriented build, the Falcon stands out as the best in its class, ready to turn every pedal stroke into a unique experience.

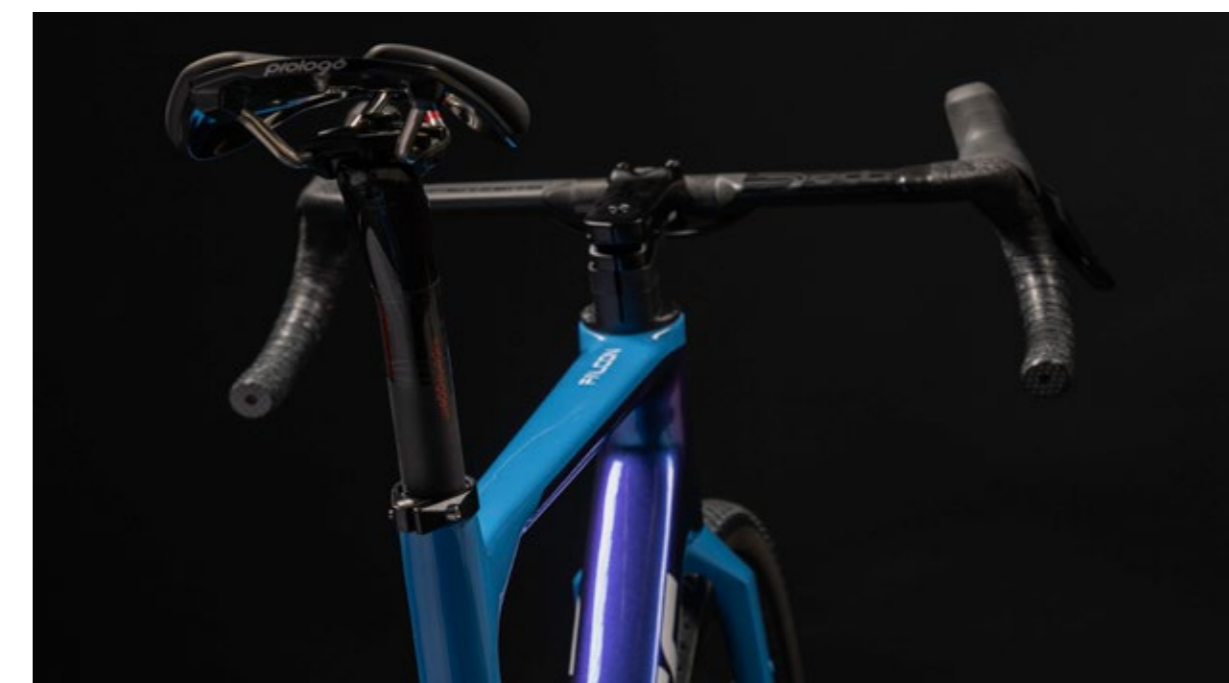





# Falcon CX

## Tech

telaio carbonio fasciato T600 3K carbon	carbon wrapped frame tube-to-tube
laminazione esterna dialed K1352U SHM combinata con M46J	outer lamination carbon 3K
sterzo D 56 integrato (dcr system) valore rigidità 115 n/mm	head tube 56 mm o.d. - full integrated cable routing stiffness valeu 115 n/mm
forcella UDM CARBON	FORK CARBON UDM
sterzo FSA HS NO 55R 1,5A SR/STD	FSA HS NO 55R 1,5A SR/STD
reggisella diametro 27,2mm	seatpost diam: 27,2 mm
copertoncini 38c a 50c max	max tires acceptance 38c to 50c max
passante anteriore 12 /100 mm	axle 12/100 mm
passante posteriore 12/142 mm UDK	axel 12/142 mm UDK
movimento centrale diametro 86 x 41,5	press fit bottom bracket press fit 86 x 41,5
<b>peso telaio 1050 g (misura m)</b>	<b>frame weight 1050 g (size m)</b>

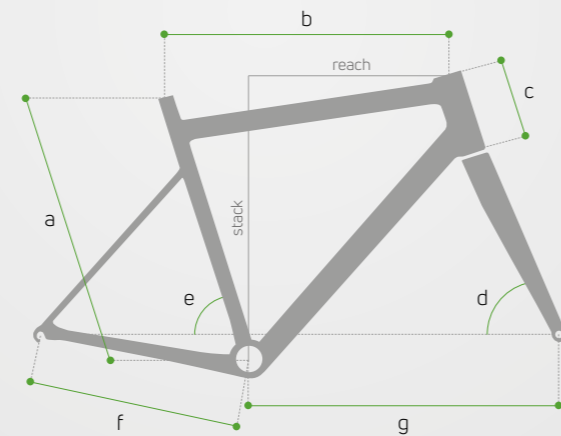

## Geometrie

size	a	b	c	d	e	f	g	stack	reach
<b>xs</b>	460	515	110	70,9°	73,5°	425	980	541	366
<b>s</b>	490	535	125	71,6°	73,5°	425	980	556	373
<b>m</b>	520	545	140	72,4°	73,5°	425	990	571	378
<b>l</b>	550	555	155	73,25°	73,5°	425	990	590	380
<b>xl</b>	570	575	175	73,25°	73,5°	425	1010	610	395
<b>xxl</b>	600	585	195	73,25°	73,5°	425	1020	628	400





# Outback CX

CARBON



## Progettata pensando alle gare su ghiaia.

Designed with gravel racing in mind.

Outback è la tua nuova bici in carbonio per il gravel, nata per darti la più ampia libertà di scelta nelle tue uscite. Che sia pura performance su strade bianche e single track oppure avventura, esplorazione e bikepacking, è stata pensata per soddisfare qualsiasi tua esigenza. Outback è una bici leggera, reattiva, maneggevole, con geometrie racing-confort, in grado di adattarsi ai molteplici usi richiesti ad una bici gravel.

The Outback is a true all-road bike. Its relaxed road geometry is designed with gravel racing in mind. It can easily handle tires of up to 38 mm, with ample space built into the frame to fit mudguards. Take it straight from road to off-road. In those long, straighter sections of trails, it rides like a dream. But no matter the terrain you encounter, this bike will ensure that your ride is all about fun!





# Outback CX

## Tech

telaio carbonio monoscocca	frame carbon monocoque
laminazione UDM / INT. M40J	UDM carbon fibers - int.m40j
UDM carbonio road disc 1-1/2	UDM carbon - tapered 1-1/2
ABC ,anod. black 8,7mm dcr	ABC ,anod. black 8,7mm dcr
reggisella 27,2 diam.	seat post diam: 27,2 mm
copertoncini max 700 x 50c	max tires acceptance 700 x 50c
perno passante anteriore 12 /100 mm	axle 12/100 mm
perno passante posteriore 12/142 mm	axle 12/142 mm
movimento centrale press fit BB86x41	bottom bracket threaded press fit BB86x41
<b>peso 1210 gr</b>	<b>frame weigh 1210 gr</b>

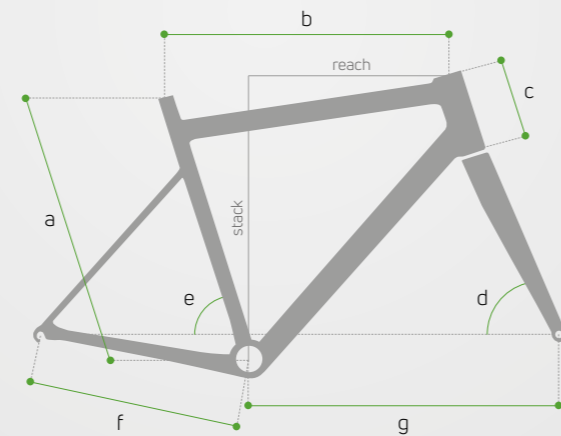
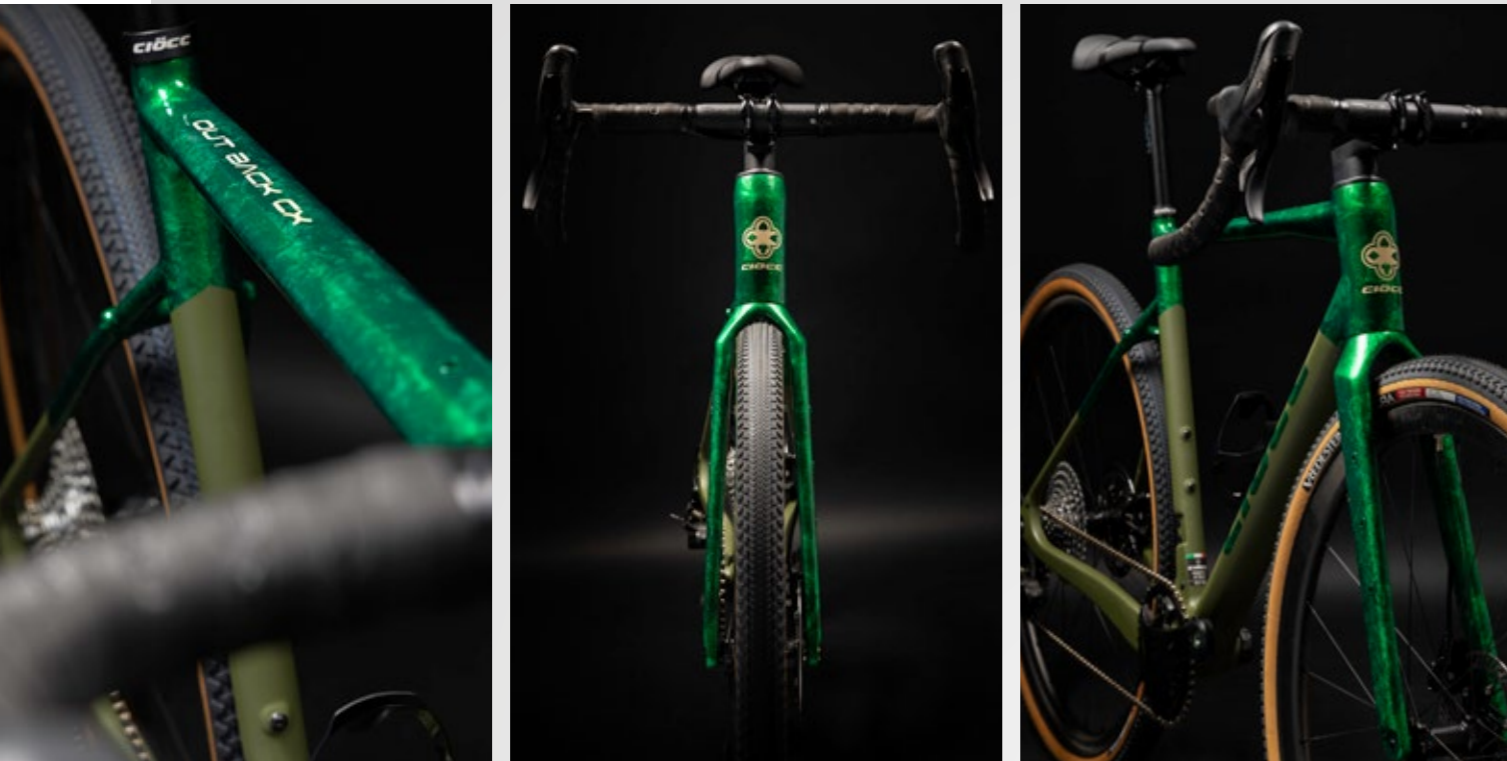

## Geometrie

size	a	b	c	d	e	f	g	stack	reach
<b>xs</b>	430	505	110	70	74,5°	435	1009	525	359
<b>s</b>	490	525	125	70,5°	74,5°	435	1018	538	369
<b>m</b>	520	535	140	71°	73,5°	435	1020	556	370
<b>l</b>	540	545	150	71,5°	73°	435	1021	568	371
<b>xl</b>	560	560	170	72°	72°	435	1026	589	374
<b>xxl</b>	580	580	190	72,5°	72,5°	435	1034	606	379





# Misfit Cx TITANIO



## Confort ed efficacia. Comfort and efficiency.

Si dice "il titanio è per sempre" e i nostri telai ne sono la conferma; la resistenza alla corrosione e le caratteristiche meccaniche ne fanno di una bici da sogno eterna. Il telaio MISFIT si distingue per una resa nel tempo invidiabile accompagnato da un buon peso e ottima comodità che ne fanno un modello da granturismo per eccellenza.

They say "titanium is forever" and our frames are the confirmation; the resistance to corrosion and the mechanical characteristics make it an eternal dream bike. The MISFIT frame stands out for its enviable performance over time accompanied by a good weight and excellent comfort which make it a touring model par excellence.





# Misfit Cx Titanium

## Tech

telaio titanio GRADE 9 (3/AL - "5V)	grade 9 titanium frame (3/AL - 5V)
UDM carbonio road disc 1-1/2	UDM carbon - tapered 1-1/2
sterzo D 56 integrato (dcr system)	head tube 56 mm - full int. cable routing
reggisella 27,2 mm	seatpost diam: 27,2 mm
passaggio ruota copertoncini 38c	max tires acceptance 38c
perno passante anteriore 12/100 mm	front through-axle 12/100 mm
perno passante posteriore 12/142 mm	rear through-axle 12/142 mm
movimento centrale 86x41 (su richiesta T47)	bottom bracket press 86x41 (on request T47)
<b>peso telaio 1.300 g (misura m)</b>	<b>frame weight 1.300 g (size m)</b>

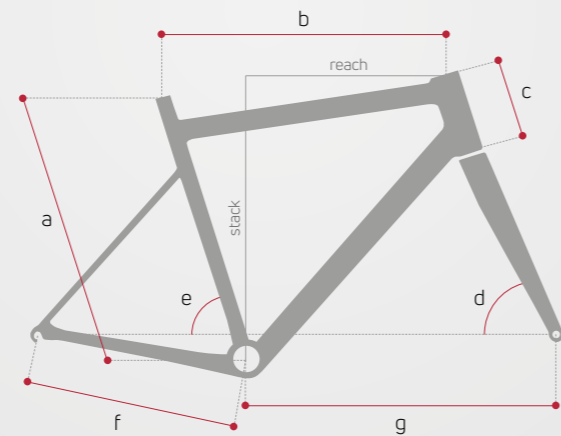

## Geometrie

size	a	b	c	d	e	f	g	stack	reach
<b>xs</b>	430	510	110	70,5°	75°	400	58	502,96	372,8
<b>s</b>	460	525	130	71,30°	74,5°	402	58	524,67	377,76
<b>m</b>	490	535	145	71,75°	73,5°	402	58,5	540,48	378,79
<b>l</b>	520	555	160	73°	73,5°	404	58,5	559,13	389,1
<b>xl</b>	540	565	170	73°	73°	407	59	569,82	390,97
<b>xxl</b>	560	575	190	73°	72,5°	410	60	587,82	390,94
<b>xxxl</b>	580	590	205	73°	72°	410	60	60,326	394,71

\* su richiesta telaio su misura / customized frame on request







# PRO RACE

LIMITED EDITION



Chromo ULTRA





# Pro Race Cx

ACCIAIO



## Quando il passato è la sfida del futuro.

When the past is the challenge of the future.

Pro Race Gravel è il nuovo telaio in acciaio dedicato al mondo gravel. Il telaio è nato in acciaio e noi lo produciamo ancora. Un telaio Gravel saldato a tig costruito con tubi Columbus Spirit Hss e forcella Carbonio. Le caratteristiche dell'acciaio in robustezza e affidabilità con un occhio al peso ed al design. Tecnicamente parlando il telaio ha perno passante posteriore, tubo sterzo a diametri differenziati, reggisella con diametro 27.2 mm per un maggiore comfort, impianto frenante a disco con tecnologia flatmount, manubrio da corsa con 12° di flare out, forcella in carbonio monoscocca con perno passante. Per garantire il massimo della versatilità il telaio è stato predisposto con attacchi per parafanghi e per portapacchi anteriori e posteriori.

The frame was born in steel and we still produce it. A tig welded Gravel frame built with Columbus Spirit tubes and Carbon fork. The characteristics of steel in strength and reliability with an eye to weight and design.





# Pro Race Cx

## Tech

telaio acciaio Columbus Spirit HSS	Steel tubing Columbus Spirit HSS
OMNICROM	OMNICROM
forcella DEDA EDG GERA D-Shape DCR POB	fork DEDA EDG GERA D-Shape DCR POB
reggisella 27,2 mm	seatpost diam: 27,2 mm
passaggio forcella max 38 mm	max fork 38 mm
perno passante anteriore 12/100 mm	front through-axle 12/100 mm
perno passante posteriore 12/142 mm	rear through-axle 12/142 mm
movimento centrale 86x41 (su richiesta T47)	bottom bracket press 86x41 (on request T47)
<b>peso telaio 1.590 g (misura m)</b>	<b>frame weight 1.590 g (size m)</b>

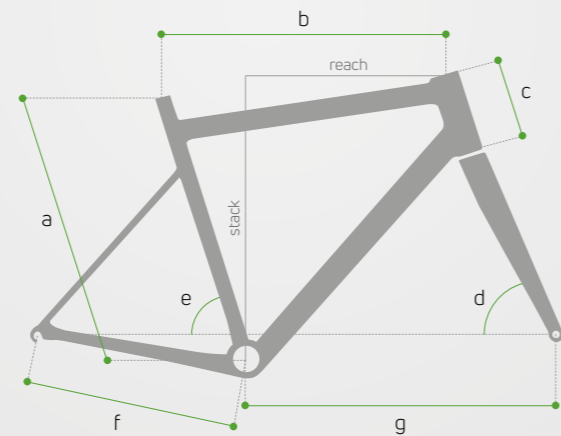

## Geometrie

size	a	b	c	d	e	f	g	stack	reach
<b>xs</b>	460	515	110	70,9°	73,5°	425	980	541	366
<b>s</b>	490	535	125	71,6°	73,5°	425	980	556	373
<b>m</b>	520	545	140	72,4°	73,5°	425	990	571	378
<b>l</b>	550	555	155	73,25°	73,5°	425	990	590	380
<b>xl</b>	570	575	175	73,25°	73,5°	425	1010	610	395
<b>xxl</b>	600	585	195	73,25°	73,5°	425	1020	628	400

\* su richiesta telaio su misura / customized frame on request

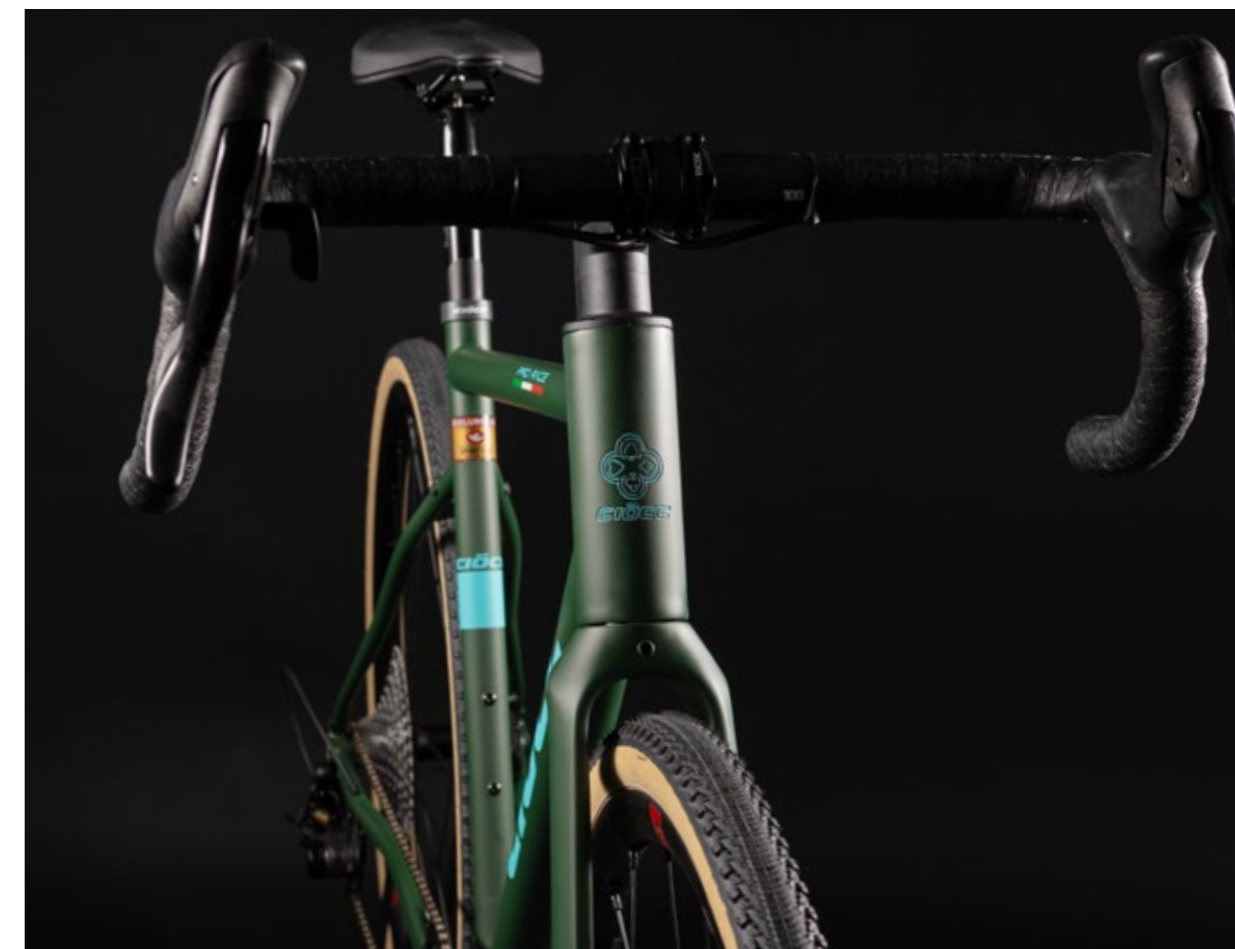



# Vintage Bikes

NEVERENDING HISTORY





# Replica

## VINTAGE



## Una grande tradizione italiana.

A great Italian tradition.

Per gli appassionati della bicicletta e di ciclismo è un marchio che richiama gli inizi della grande tradizione artigianale telaistica italiana. È negli anni 60 che nasce una piccola bottega artigiana che comincia a produrre per alcuni corridori dalle esigenze particolari. Ciöcc alla fine degli anni sessanta compare tra i professionisti e si conferma leader nella produzione delle biciclette da corsa raccogliendo successi straordinari quali il campionato mondiale del 1977 e le olimpiadi di Mosca 1980. Squadre professionistiche di prestigio come Santini Conti Krups, Italonifica Navigare e altre sono state equipaggiate con biciclette Ciöcc arrivando a successi internazionali. Da allora l'azienda si è evoluta ed ha visto diversi cambiamenti di proprietà, mantenendo intatta la sua tradizione, la sua caratteristica attenzione ai dettagli, all'evoluzione della bicicletta e del suo utilizzo, cogliendo con successo le opportunità offerte dalla produzione dei telai in carbonio. Oggi dopo 40 anni ciöcc si propone ancora sul mercato come marchio leader offrendo biciclette uniche per qualità, design e prestazioni.

For the passionate cyclist, is a mark that recalls the beginnings of the great Italian handcraft tradition in the production of frames. It was 60 years ago, that Ciöcc working from a small artisan shop, produced high quality frames for some very demanding professional riders sixty years on and Ciöcc still present in the professional ranks, as a confirmed leader in the production of race frames. Picking up along the way extraordinary successes, such as the 1977 world championships and the olympiads of Moscow in 1980. Professional teams of prestige Santini Conti Krups, Italonifica Navigare and others have been equipped with Ciöcc cycles, reaching international successes. As the company evolved, it has seen different changes of ownership realising the importance of its origins and maintaining the traditions, the characteristics and the attention to detail of the brands as it evolves in to a new era offering production of carbon fibre frames. Today, Ciöcc is still a market leader, offering unique bicycles for quality, design and performance.





# San Cristobal 77

## VINTAGE



## Vintage

### Tech

acciaio columbus sl niobium	steel frame - columbus tubing sl niobium
misure disponibili 13 sempre centro/centro	centro 13 measures available c/c
forcella 1" a filetto	threaded fork
cromatura forcella completa	full chromed fork
cromatura congiunzioni anteriori	chromed chain stay
cromatura del carro posteriore	chromed rear stay
incisione ciöcc su forcella, scatola movimento e pendine	engraved ciöcc logo on fork and bottom bracket
colori personalizzati	customized colors
<b>scatola movimento ita</b>	<b>italian bottom bracket</b>

### Geometrie

a	a1	b	c	d	e
C/C	C/F	TO	ANG	AVA	STE
470	490	520	74°	580	110
480	500	520	74°	580	115
490	510	525	74°	585	120
500	520	530	73,5°	585	125
510	530	535	73,5°	585	135
520	540	540	73,5°	585	145
530	550	550	73,5°	585	155
540	560	555	73,5°	590	160
550	570	565	73°	590	165
560	580	570	73°	590	170
570	590	575	73°	595	185
580	600	580	72,3°	595	195
590	610	585	72,3°	595	205

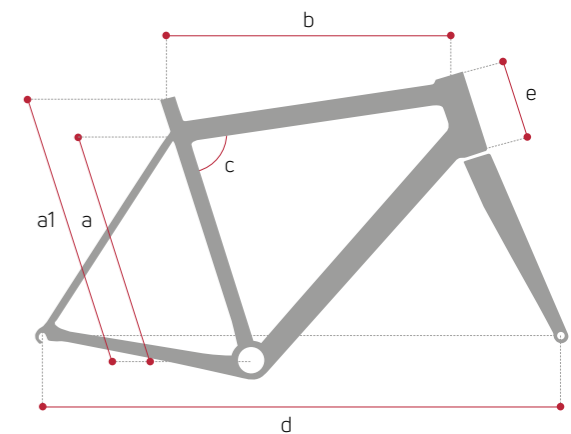





# Tandem

NEVERENDING TEAM







# Tandem

CARBON



## Tandem Carbon

### Tech

laminazione est. 3k / INT. M40J OUTER	lamination carbon 3K
forcella carbon UDM 1-1/8 1-1/2 fork c	carbon monocoque 1"1/8 / 1"1/2
sterzo abc, anod. black 8,7 mm 1-5"	head set ABC, anod. black 8,7 mm 1-5"
dimensioni / geometria personalizzabile	only customized on request
tubo sella 31,6 mm posteriore 27,2 mm anteriore	seatpost diam: 31,6 mm rear 27,2 front
passaggio ruota copertoncini 700 x 28	max tires acceptance 700 x 28c
sistema freni flat mount	flat mount braking system - disc 160 mm
perno passante anteriore 12/100 mm	axle 12/100 mm
perno passante posteriore 12/142 mm	axel 12/142 mm
movimento centrale ant. assiale post. filetto bsa	axial front threaded bsa post
<b>peso telaio 2.900 g</b>	<b>frame weight 2.900 g</b>



### Geometrie

size	a1	a2	b1	b2	c1	c2	h
m/s	485	433	545	585	73°	73°	1700
l/s	505	433	560	690	73°	73°	1720
x/s	535	433	600	690	73°	73°	1750
x/m	560	483	600	715	73°	73°	1780
xx/l	610	533	625	740	72°	73°	1850

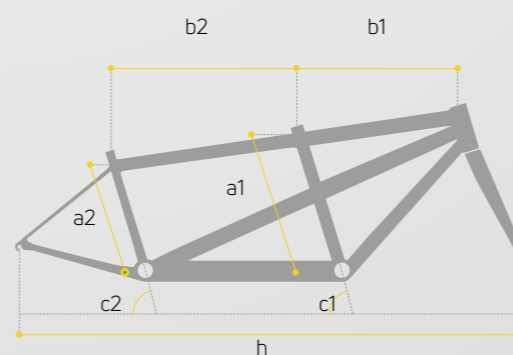

\* su richiesta telaio su misura / customized frame on request

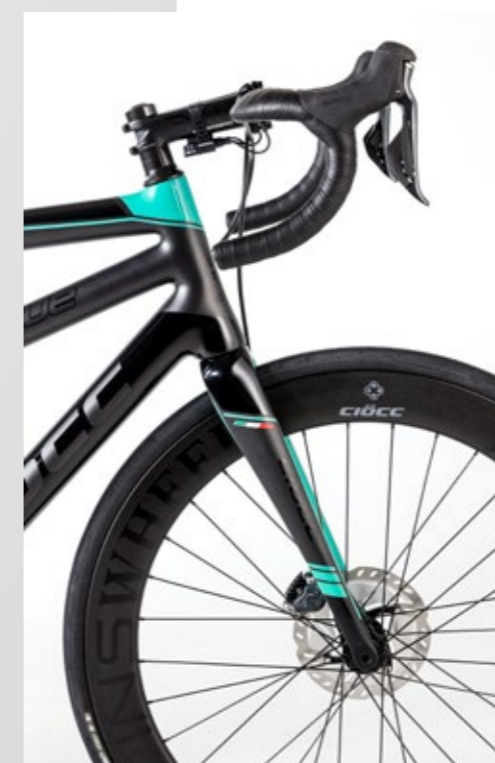





# Tandem

ALLUMINIO



## Tandem Alluminio

### Tech

telaio alluminio 6061 SL	frame triple butted alu 6061 SL triple butted tubing
forcella carbon UDM 1-1/2	fork full carbon 1"1/2
ABC ,anod. black 8,7mm 1-1-8" / 1-5"	ABC ,anod. black 8,7mm 1-1-8" / 1-5"
dimensioni / geometria personalizzabile - su richiesta	only customized on request
tubo sella 31,6 mm posteriore 27,2 mm anteriore	seat post diam: 31,6 mm post / 27,2 front
passaggio ruota copertoncini 700 x 28	max tires acceptance 700 x 28c
sistema freni flat mount - 160 mm	flat mount braking system - disc 160 mm
perno passante anteriore 12 /100 mm	axle 12/100 mm
perno passante posteriore 12/142 mm	axel 12/142 mm
ant. assiale - post. filetto bsa	axial front - threaded bsa post
<b>peso telaio 3900 gr</b>	<b>frame weigh 3900 gr</b>

### Geometrie

size	a1	a2	b1	b2	c1	c2	h
m/s	485	433	545	585	73°	73°	1700
l/s	505	433	560	690	73°	73°	1720
x/s	535	433	600	690	73°	73°	1750
x/m	560	483	600	715	73°	73°	1780
xx/l	610	533	625	740	72°	73°	1850

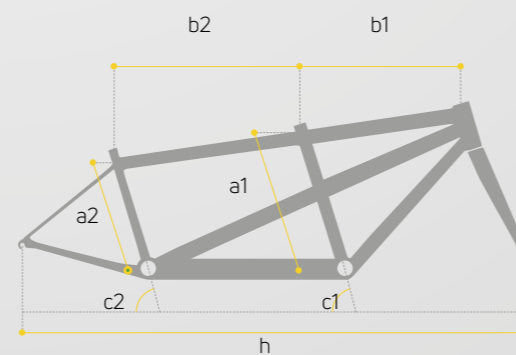

\* su richiesta telaio su misura / customized frame on request







# Electric Bikes

NEVERENDING POWER





# E-Supremo ROAD

CARBONIO



## Eleganza minimale. Minimalist elegance.

Costruire una bicicletta è un mestiere, fare una Ciocc è un'arte. Basta uno sguardo per capire cosa li rende diversi da tutti gli altri. Sono perfetti, perché sono fatti su misura, a mano, in Italia. Sono innovative, perché sono il frutto di ricerche scientifiche, tecnologie avveniristiche e intuizioni visionarie. Sono unici, perché sono Ciocc. La loro passione, il carattere e le specifiche qualità fisiche rendono ogni ciclista un individuo. Semplicemente unico. E siamo convinti che le biciclette debbano essere altrettanto uniche. Il telaio monoscocca in carbonio di Supremo è realizzato con il nostro UD T800 3K System: la garanzia della massima qualità. Durante la fabbricazione, gli strati di carbonio vengono avvolti attorno a forme di polistirolo espanso con superfici perfettamente lisce. Realizziamo biciclette artigianali 100% in carbonio, forcella compresa, che sono sinonimo di vero Made in Italy.

Building a bicycle is a profession, making a Ciocc is an art. One glance is enough to understand what makes them different from all the others. They are perfect, because they are made to measure, by hand, in Italy. They are innovative, because they are the result of scientific research, futuristic technologies and visionary intuitions. They are unique, because they are Ciocc. Their passion, character and specific physical qualities make every cyclist an individual. Simply unique. And we are convinced that bicycles must be equally unique. Supremo's carbon monocoque frame is made with our UD T800 3K System: the guarantee of the highest quality. During manufacturing, the layers of carbon are wrapped around polystyrene foam shapes with perfectly smooth surfaces. We make 100% carbon handcrafted bicycles, including the fork, which are synonymous with true Made in Italy.







# E-Supremo

## Tech

carbonio fasciato laminaz. est. 3k /INT. M40J	carbon wrapped frame tube-to-tube
sterzo D56 integrato (DCR system)	head tube 56 mm o.d. full integrated cable routing
3K CARBON FKT DCR	3K CARBON FKT DCR
FSA HS NO 55R 1,5A SR/STD DCR	FSA HS NO 55R 1,5A SR/STD DCR
diametro 31,6	seat post diam: 31,6 mm
copertoncini max 30c	max tires acceptance 30c
passante anteriore 12 /100 mm	axle 12/100 mm
passante posteriore 12/142 mm	axel 12/142 mm

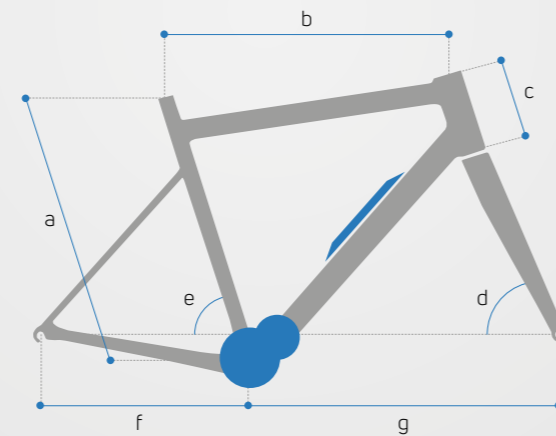
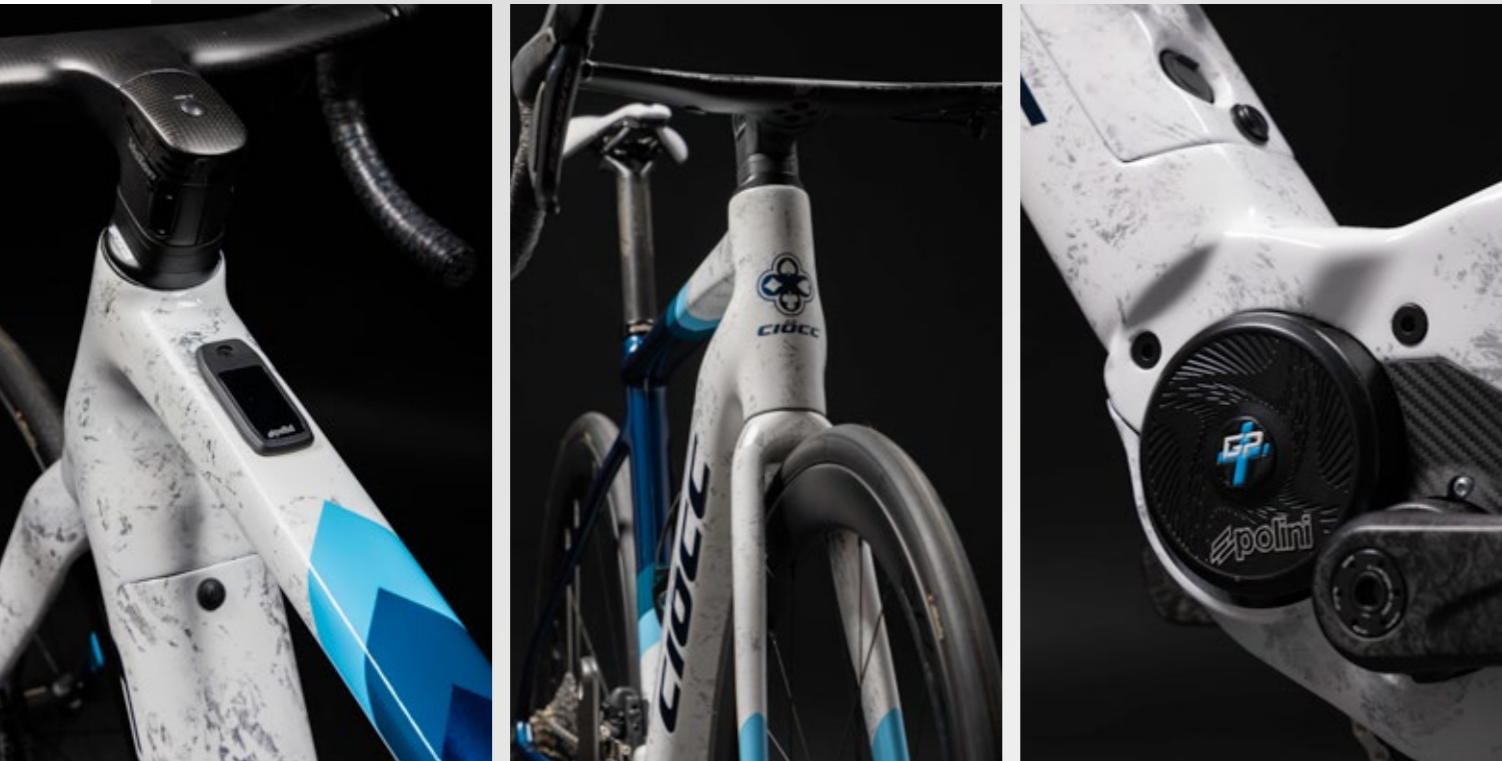

## Geometrie

size	a	b	c	d	e	f	g+f
xs	450	515	130	70°	74,5°	437	580
s	470	525	145	70,5°	74,5°	437	580
m	490	535	150	70,5°	74°	440	585
l	520	550	155	71,5°	73,5°	440	585
xl	540	560	175	72°	73,5°	440	590
xxl	570	575	195	72°	73°	443	600
xxxl	590	585	205	72,5°	72,5°	443	600

\* su richiesta telaio su misura / customized frame on request





# Thor Evo 6.0 ROAD

CARBONIO



## Una nuova esperienza di pedalata assistita.

A new bike experience.

La Thor Evo 6.0 è la e-Road Bike più leggera - molto più leggera di altre bici nella sua categoria. Il leggerissimo telaio in fibra di carbonio monococca ti farà danzare sui pedali e tuffarti ad aggredire le curve. Il leggero motore Polini EP3 + PLUS raddoppierà i tuoi sforzi grazie ai 250 watt di assistenza. La curva di erogazione del motore fornisce potenza perfettamente in linea con la tua normale cadenza e non dà resistenza se pedali senza assistenza.

The Thor Evo 6.0 is the lightest e-Road Bike - much lighter than other bikes in its class. The lightweight monocoque carbon fiber frame will make you dance on the pedals and dive to attack the curves. The light Polini EP3 + PLUS motor will double your efforts thanks to the 250 watts of assistance. The output curve of the engine provides power perfectly in line with your normal cadence and does not give resistance if you pedal without assistance.





# Thor Evo 6.0

## Tech

carbonio monoscocca laminazione esterna UDM	carbon monocoque outer lamination carbon UDM
sterzo D56 integrato (dcr system)	head tube 56 mm o.d. full integrated cable routing
UDM CARBONDCR (aero cable routing)	UDM CARBON FKT DCR (aero cable routing)
FSA HS NO 55R 1,5A SR/STD DCR	FSA HS NO 55R 1,5A SR/STD DCR
diametro 27,2	seat post diam: 27,2 mm
copertoncini max 30c	max tires acceptance 30c
passante anteriore 12 /100 mm	axle 12/100 mm
passante posteriore 12/142 mm	axel 12/142 mm

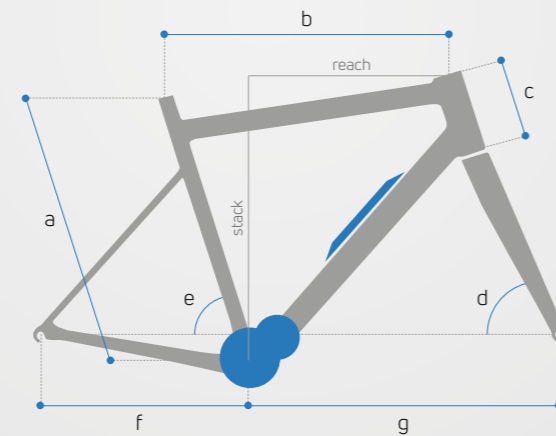
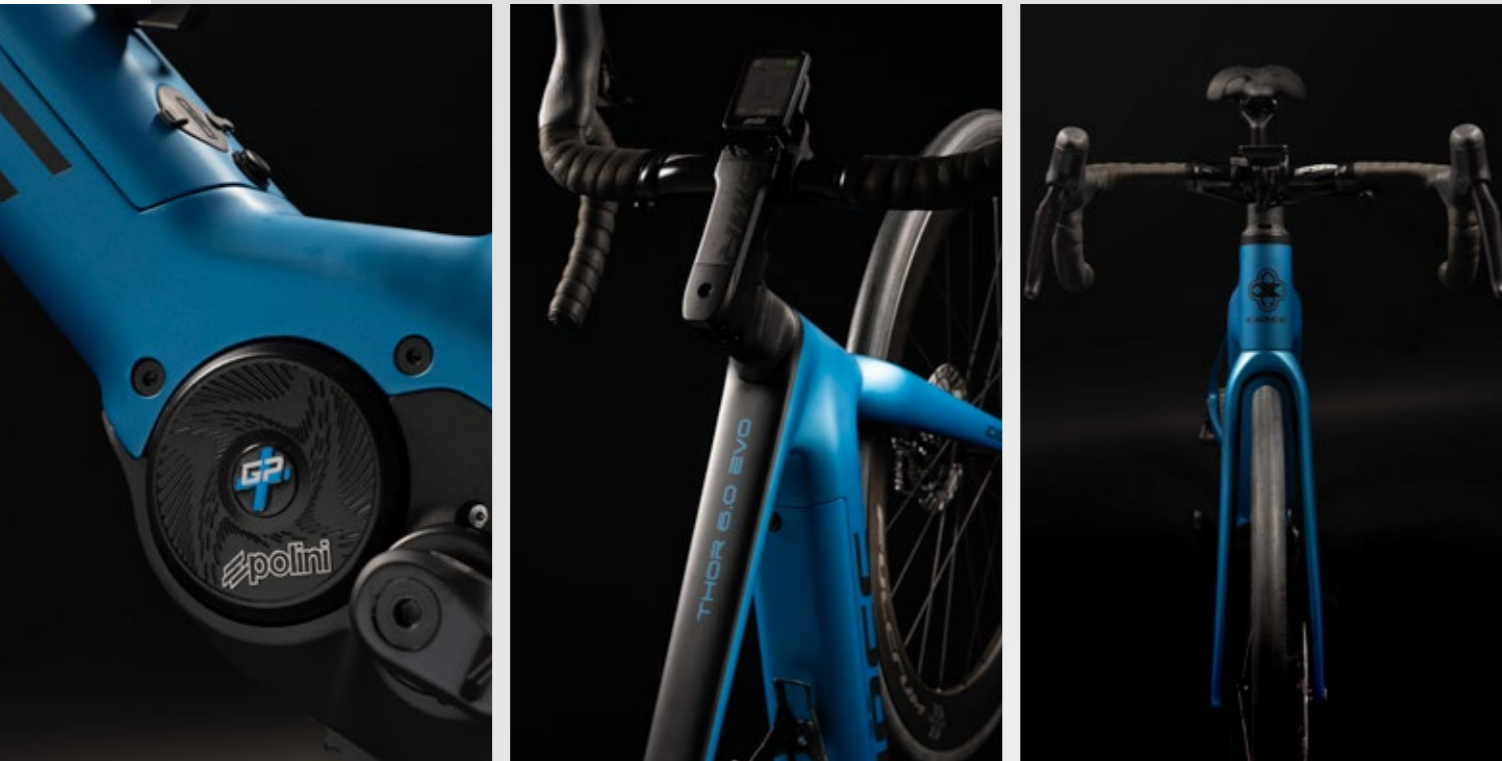

## Geometrie

size	a	b	c	d	e	f	g+f	stack	reach
s	450	515	114	71,5°	75°	419	994	530,44	370,97
m	490	536	133	72°	74°	419	1002	550,23	377,13
l	530	557	159	72°	73,5°	419	1014	576,77	385,61
xl	570	578	186	72°	73°	419	1029	602,52	393,52





# E-Veloce Endurance

ALLUMINIO



## Una bici da corsa che abbina performance e percorrenza.

A racing bike that combines performance and mileage.

E-Veloce è una vera bici da corsa che abbina assistenza, performance, bellezza estetica e lunga percorrenza. Le salite, anche le più impervie, non saranno più un ostacolo, ma solo una tappa da raggiungere godendosi anche il panorama. Non vi resterà che scegliere il percorso e divertirvi, senza porvi limiti.

E-Veloce is a real racing bike that combines assistance, performance, aesthetic beauty and long distance. The climbs, even the most inaccessible, will no longer be an obstacle, but only a stage to be reached while also enjoying the view. You just have to choose the path and have fun, without setting yourself limits.





# E-Veloce Endrance

## Tech

alluminio 6061	frame alu - 6061
UDM carbon DCR (aero cable routing)	UDM carbon DCR (aero cable routing )
FSA HS NO 55R 1,5A DCR	FSA HS NO 55R 1,5A DCR
diametro 27,2	seat post diam: 27,5 mm
copertoncini max 32c	max tires acceptance 32c
perno passante anteriore 12 /100 mm	axle 12/100 mm
perno passante posteriore 12/142 mm	axle 12/142 mm

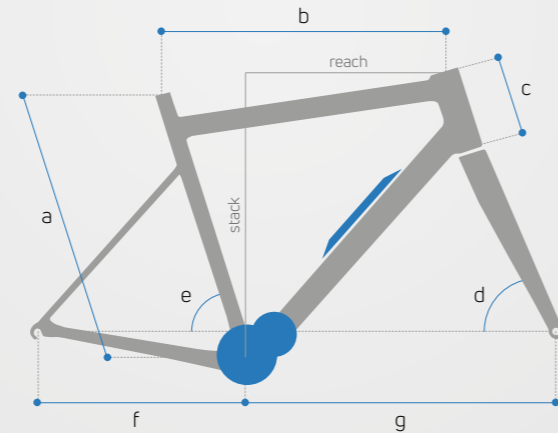

## Geometrie

size	a	b	c	d	e	f	g	stack	reach
s	460	515	135	70°	74,5°	450	595	550	362,2
m	490	535	135	71°	74°	450	605	554	381
l	520	550	145	72,5°	73,5°	450	596	575	381
xl	550	565	160	73°	73,5°	450	605	586	391
xxl	575	585	160	73°	73,5°	450	619	605	399





# E-Xtro Cx

CARBON



## Avventura senza Limiti. Adventure Without Limits.

La E-Xtro Carbon è stata progettata per portarti ancora più lontano, attraverso sentieri selvaggi e strade sterrate, per avventure sempre più straordinarie. Realizzata in leggero e resistente carbonio 4K, condivide il telaio, il motore e la batteria con la sua versione stradale, ma è dotata di pneumatici più larghi e componenti specifici per il fuoristrada, per portarti ovunque tu voglia andare. Sei sempre tu, solo con una marcia in più.

The E-Xtro Carbon has been designed to take you even further, along rugged trails and dirt roads, for ever more remarkable adventures. Crafted from lightweight and durable 4K carbon, it shares the frame, engine, and battery with its road counterpart but features larger tires and specialized off-road components to go wherever you want. It's always you, only with an extra edge.





# E-Xtro Cx

## Tech

telaio carbonio fasciato T600 3K carbon	carbon wrapped frame tube-to-tube
laminazione esterna dialed K1352U SHM combinata con M46J	outer lamination carbon 3K
sterzo D 56 integrato (dcr system) valore rigidità 115 n/mm	head tube 56 mm o.d. - full integrated cable routing stiffness valeu 115 n/mm
forcella UDM CARBON	FORK CARBON UDM
sterzo FSA HS NO 55R 1,5A SR/STD	FSA HS NO 55R 1,5A SR/STD
reggisella diametro 27,2mm	seatpost diam: 27,2 mm
copertoncini max 38c/50c	max tires acceptance 38c/50c
passante anteriore 12 /100 mm	axle 12/100 mm
passante posteriore 12/142 mm (su richiesta UDK)	axel 12/142 mm (on request UDK)
movimento centrale diametro 86 x 41,5	press fit bottom bracket press fit 86 x 41,5

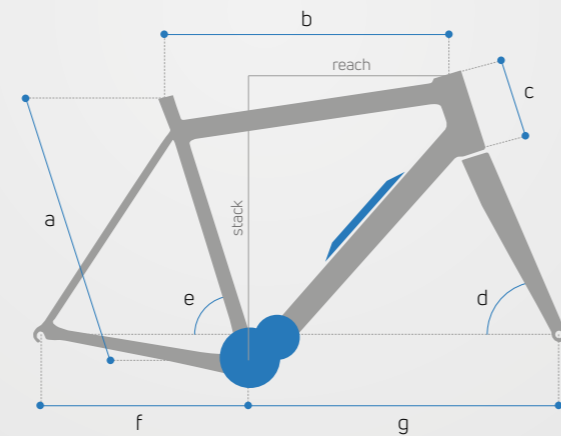

## Geometrie

size	a	b	c	d	e	f	g	stack	reach
xs	460	515	100	70,9°	73,5°	425	980	541	366
s	490	535	125	71,6°	73,5°	425	980	556	373
m	520	545	140	72,4°	73,5°	425	990	571	378
l	550	555	155	73,25°	73,5°	425	990	590	380
xl	570	575	175	73,25°	73,5°	425	1010	610	395
xxl	600	585	195	73,25°	73,5°	425	1020	628	400







# E-THOR CX

LIMITED EDITION



Chromo ULTRA





# E-Thor CX

CARBON



## Una pedalata perfetta, ovunque e per tutti.

A perfect ride, everywhere  
and for everyone.

La Thor Gravel è stata disegnata per portarti ancora di più in mezzo ai boschi, più lontano sulle strade bianche, per avventure sempre più belle. Condivide il telaio, il motore e la batteria con la sua cugina su strada, ma prevede pneumatici dalla sezione maggiore ed alcuni componenti adatti all'avventura per portarti ovunque tu desideri. Sei sempre tu, solo più veloce.

The Thor Gravel has been designed to take you even further into the woods, farther on the dirt roads, for even more beautiful adventures. It shares the frame, engine and battery with its cousin on the road, but has larger tires and some components suitable for adventure to take you wherever you want. It's always you, only faster.

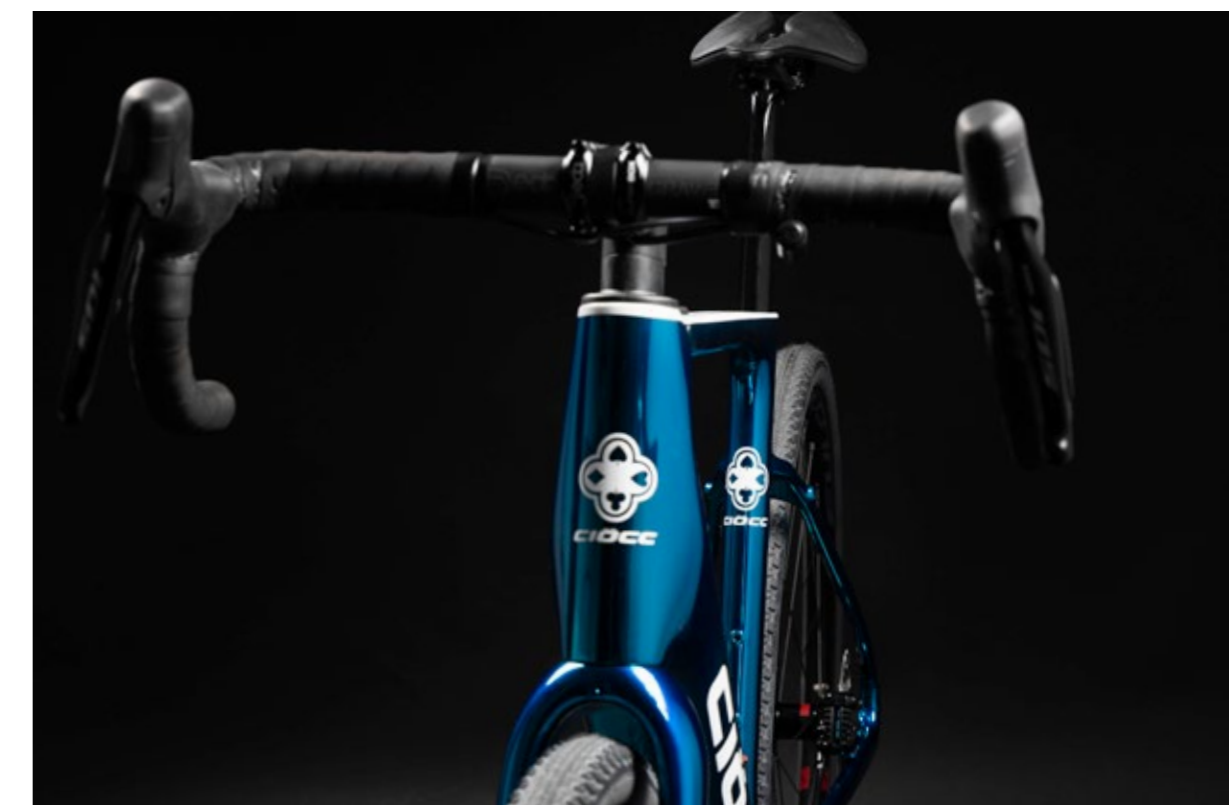



# E-Thor CX

## Tech

carbonio monoscocca laminazione estrna udm	carbon monocoque outer lamination carbon udm
sterzo D56 integrato (dcr system)	head tube 56 mm o.d. full integrated cable routing
UDM CARBON DCR (aero cable routing)	UDM CARBON FKT DCR (aero cable routing)
custom carbon aero	custom carbon aero
copertoncini max 38c	max tires acceptance 38c
passante anteriore 12 /100 mm	axle 12/100 mm
passante posteriore 12/142 mm	axel 12/142 mm



250 Wh EVO BOTTLE BATTERY  
+ POWER BANK USB

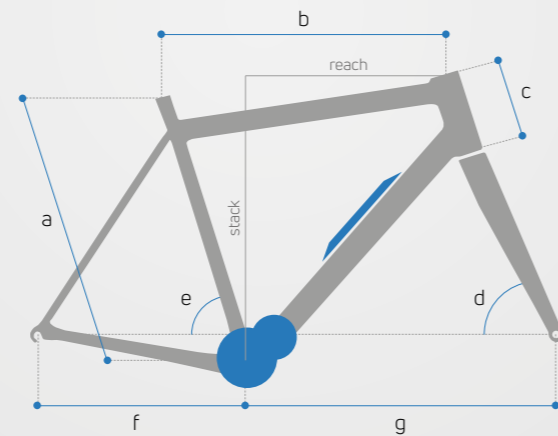

## Geometrie

size	a	b	c	d	e	f	g+f	stack	reach
s	450	52,5	132	70°5	74,5°	445	1024,5	538	375,5
m	480	53,5	152	71°	74°	445	1026,5	556	375,5
l	500	54,5	165	71,5°	73,5°	445	1031,1	570	370,1
xl	520	56	185	72°	73°	445	1036,4	589	380
xxl	540	57,5	205	72°	72,5°	445	1042,5	609	384



# E-Thor CX URBAN

CARBON



## Tech

carbonio monoscocca laminazione estrna udm	carbon monocoque outer lamination carbon udm
sterzo D56 integrato (dcr system)	head tube 56 mm o.d. full integrated cable routing
UDM CARBON DCR (aero cable routing)	UDM CARBON FKT DCR (aero cable routing)
custom carbon aero	custom carbon aero
copertoncini max 38c	max tires acceptance 38c
passante anteriore 12 /100 mm	axle 12/100 mm
passante posteriore 12/142 mm	axel 12/142 mm

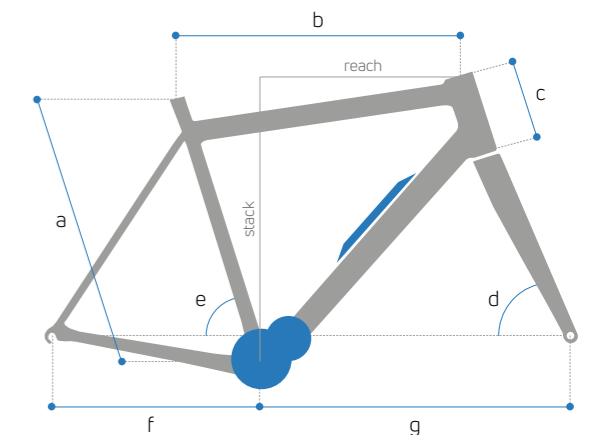

## Geometrie

size	a	b	c	d	e	f	g+f	stack	reach
s	450	52,5	132	70°5'	74,5°	445	1024,5	538	375,5
m	480	53,5	152	71°	74°	445	1026,5	556	375,5
l	500	54,5	165	71,5°	73,5°	445	1031,1	570	370,1
xl	520	56	185	72°	73°	445	1036,4	589	380
xxl	540	57,5	205	72°	72,5°	445	1042,5	609	384



# E-xplorer Cx

ALLUMINIO



## Una nuova esperienza di pedalata assistita.

A new bike experience.

Con telaio in alluminio serie 6061, rappresenta un perfetto equilibrio, è la bicicletta a pedalata assistita gravel, ovvero perfetta per il cicloturismo, per i lunghi viaggi o per le escursioni giornaliere immerse nella natura. Ogni fondo è il suo terreno ideale, che sia asfaltato o sterrato, si troverà sempre a suo agio, ottimizzando al massimo l'esperienza di guida. Le particolari geometrie del telaio unite alla sicurezza dei freni sono i giusti alleati per comode vacanze in bicicletta con bagagli compresi.

With 6061 series aluminum frame, it represents a perfect balance, it is the gravel pedal assisted bicycle, which is perfect for cycle tourism, for long trips or for day trips immersed in nature. Each surface is its ideal terrain, whether asphalted or unpaved, it will always be at ease, optimizing the driving experience to the maximum. The particular geometries of the frame combined with the safety of the brakes are the right allies for comfortable cycling holidays with luggage included.







# E-xplorer Cx

## Tech

telaio 6061 alluminio classe T6 Deda Acciai	frame triple butted alu 6061 T6 Deda Acciai triple butted tubing
sterzo D56 integrato (dcr system)	head tube 56 mm o.d. full integrated cable routing
UDM CARBON DCR (aero cable routing)	UDM CARBON FKT DCR (aero cable routing)
reggisella 27,2 mm	seat post diam: 27,2 mm
copertoncini max 38c	max tires acceptance 38c
passante anteriore 12 /100 mm	axle 12/100 mm
passante posteriore 12/142 mm	axel 12/142 mm

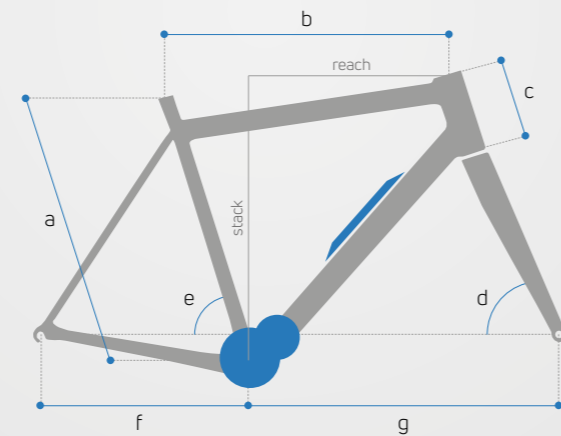

## Geometrie

size	a	b	c	d	e	f	g	stack	reach
s	460	515	135	70°	74,5°	450	595	550	362,2
m	490	535	135	71°	74°	450	605	554	381
l	520	550	145	72,5°	73,5°	450	596	575	381
xl	550	565	160	73°	73,5°	450	605	586	391
xxl	575	585	160	73°	73,5°	450	619	605	399





# E-Xplorer URBAN

ALLUMINIO



## Tech

telaio 6061 alluminio classe T6 Deda Acciai	frame triple butted alu 6061 T6 Deda Acciai triple butted tubing
sterzo D56 integrato (dcr system)	head tube 56 mm o.d. full integrated cable routing
UDM CARBON DCR (aero cable routing)	UDM CARBON FKT DCR (aero cable routing)
reggisella 27,2 mm	seat post diam: 27,2 mm
copertoncini max 38c	max tires acceptance 38c
passante anteriore 12 /100 mm	axle 12/100 mm
passante posteriore 12/142 mm	axel 12/142 mm

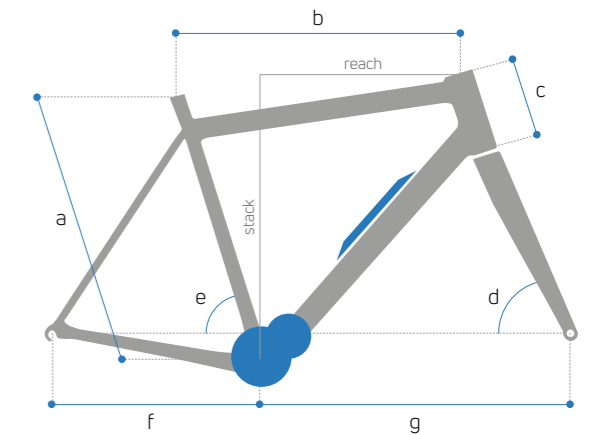

## Geometrie

size	a	b	c	d	e	f	g	stack	reach
s	460	515	135	70°	74,5°	450	595	550	362,2
m	490	535	135	71°	74°	450	605	554	381
l	520	550	145	72,5°	73,5°	450	596	575	381
xl	550	565	160	73°	73,5°	450	605	586	391
xxl	575	585	160	73°	73,5°	450	619	605	399



# E-Lady Urban

ALLUMINIO



# E-Lady Urban

## Tech

alluminio aegis scandium deda	frame alu-deda tubing aegis scandium
ALL.7005 energy	triple butted tubing - all-7005 energy
UDM carbonio DCR road disc 1-1/2	fork full carbon DCR 1"1/2 -gravel
ABC ,anod. black 8,7mm 1-1-8" / 1-5"	ABC ,anod. black 8,7mm 1-1-8" / 1-5"
diametro 31,6	seat post diam: 31,6 mm
passaggio ruota copertoncini da max 700 x 38	max tires acceptance 700 x 38c
perno passante anteriore 12 /100 mm	axle 12/100 mm
perno passante posteriore 12/142 mm	axel 12/142 mm

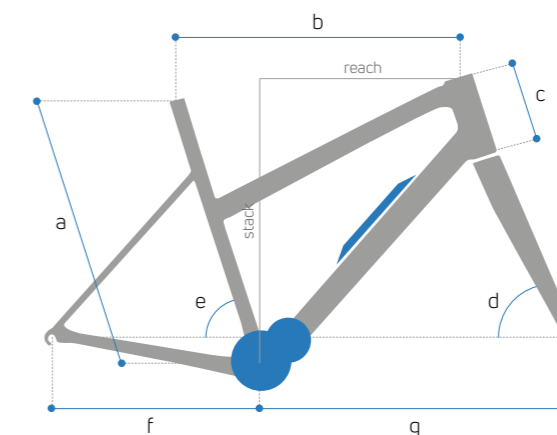

## Geometrie

size	a	b	c	d	e	f	g
xs	430	510	155	70,5°	74,5°	438	595
s	460	520	165	70,5°	74,5°	438	607
m	490	535	165	70,5°	74,3°	445	622





# Blaze carbon 800<sub>watt</sub>

CARBONIO



## Una bici da fuoristrada leggera e performante.

An off-road bike light and performing.

Blaze Full Carbon è costruita con un telaio leggero in carbonio monoscocca, trasmissioni, ruote e allestimenti di alto livello. Una bici da fuoristrada leggera, maneggevole, performante ma con un motore che ti permetterà di ampliare gli orizzonti delle tue uscite.

Blaze Full Carbon is built with a lightweight monocoque carbon frame, high-end transmissions, wheels and equipment. A light off-road bike, easy to handle, performing but with an engine that will allow you to broaden the horizons of your outings.





# Blaze Carbon 800 watt

## Tech

full carbon UDM, HPC, high performance composite	full carbon UDM, HPC, high performance composite
tapared fsa no,55 anod. black 8,7mm 1-1-8" / 1-5"	tapared fsa no,55 anod. black 8,7mm 1-1-8" / 1-5"
reggisella 31.6	seat post diam 31.6
sistema freni post mount	sistema freni post mount
perno passante posteriore 12/148 mm boost	perno passante posteriore 12/148 mm boost
160 15/110 boost ( 29" )	160 15/110 boost ( 29" )
Polini EP3 MX EVO	Polini EP3 MX EVO

## Tech Enduro Am/Trial

	Enduro	Am/Trial
ruota anteriore / front wheel	29x2.6	29x2.35
ruota posteriore / rear wheel	27,5x2.6	27,5x2.35
ammortizzatore / shock absorber	205x65mm Trunion	205x60mm Trunion
corsa posteriore / rear run	1550mm	1540mm
forcella / fork	29" 160mm / 170mm	29" 140mm / 150mm

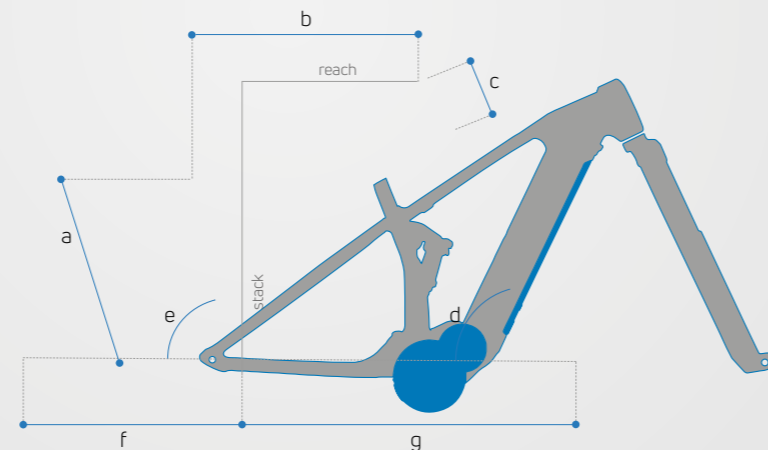

## Geometrie

size	a	b	c	d	e	f	reach
s	42	585	120	64,5°	75°	469	411
m	44	610	120	64,5°	75°	469	436
l	48	640	130	64,5°	75°	469	463





# B-Power 1000 watt

## ROAD - GRAVEL



**Una nuova esperienza  
di pedalata assistita.**  
A new bike experience.







# B-Power 1000 Watt

## Tech

alluminio aegis scandium deda	alluminio aegis scandium deda
ALL 7005 energy	ALL 7005 energy
UDM carbonio road disc 1-1/8 1-1/2	UDM carbon - tapered 1 1/8 - 1 1/2
ABC ,anod. black 8,7mm 1-1-8" / 1-5"	ABC ,anod. black 8,7mm 1-1-8" / 1-5"
diametro 31,6	seat post diam: 31,6 mm
copertoncini max 700 x 28	max tires acceptance 700 x 28c
perno passante anteriore 12/100 mm	axle 12/100 mm
perno passante posteriore 12/142 mm	axle 12/142 mm



## Geometrie ROAD

size	a	b	c	d	e	f	g
s	470	525	125	70,5°	74,5°	430	58,5
m	490	535	130	70,5°	74°	435	58,5
l	520	550	145	71,5°	73,5°	435	590
xl	540	560	155	72°	73,5°	437	590
xxl	570	57,5	175	72°	73°	437	599
xxxl	590	58,5	185	72,5°	72,5°	440	601

## Geometrie GRAVEL

size	a	b	c	d	e	f	g
s	470	525	145	70,5°	74,5°	449	600
m	490	535	150	70,5°	74°	450	600
l	520	550	155	71,5°	73,5°	450	605
xl	540	560	175	72°	73,5°	452	615
xxl	570	570	195	72°	73°	455	615

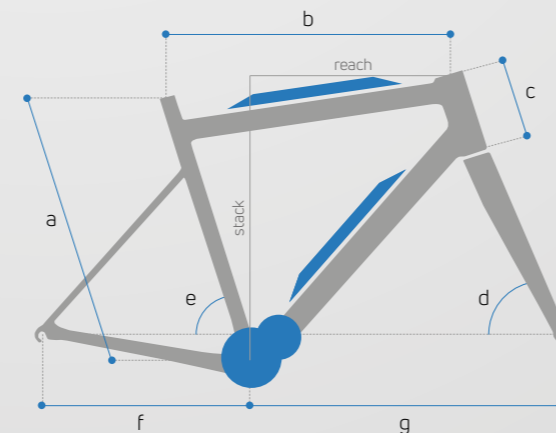



# Tandem B-POWER 1000 watt

GRAVEL ALLUMINIO



\* su richiesta telaio su misura / customized frame on request



## Tandem B-POWER

### Tech

telaio alluminio 6061 SL DEDA ACCIAI	frame triple butted alu 6061 SL DEDA ACCIAI triple butted tubing
forcella carbon UDM 1-1/2 sistema DCR ABC ,anod. black 8,7mm	fork full carbon 1-1/2 system DCR ABC ,anod. black 8,7mm
<b>dimensioni / geometria personalizzabile - su richiesta</b>	<b>only customized on request</b>
tubo sella 31,6 mm posteriore 27,2 mm anteriore	seat post diam: 31,6 mm post / 27,2 front
passaggio ruota copertoncini 38c	max tires acceptance 38c
sistema freni flat mount - 160 mm	flat mount braking system - disc 160 mm
perno passante anteriore 12 /100 mm	axle 12/100 mm
perno passante posteriore 12/142 mm	axel 12/142 mm
ant. assiale - post. filetto bsa	axial front - threaded bsa post
<b>peso telaio 3900 gr</b>	<b>frame weigh 3900 gr</b>

**250 + 250 Wh EVO BOTTLE BATTERY**  
+ POWER BANK USB





# Tandem B-POWER 1000 watt

MTB ALLUMINIO



\* su richiesta telaio su misura / customized frame on request



## Tandem B-POWER

### Tech

telaio alluminio 6061 SL DEDA ACCIAI	frame triple butted alu 6061 SL DEDA ACCIAI triple butted tubing
forcella Full carbon FK275 Plus UD rigida conica 1-1/8" 1-1/5" Boost tapered 15x110mm 29	Full carbon Rigid tapered fork 1-1/8" 1-1/2" Boost tapered 15x110mm 29
<b>dimensioni / geometria personalizzabile - su richiesta</b>	<b>only customized on request</b>
tubo sella 31,6 mm posteriore 27,2 mm anteriore	seat post diam: 31,6 mm post / 27,2 front
passaggio ruota copertoncini 29*2,4c	max tires acceptance 29*2,4c
sistema freni flat mount - 180 mm	flat mount braking system - disc 180 mm
perno passante anteriore 15 /110 mm	axle 15/110 mm
perno passante posteriore 12/148 mm boost	axel 12/148 mm boost
ant. assiale - post. filetto bsa	axial front - threaded bsa post
<b>peso telaio 3900 gr</b>	<b>frame weigh 3900 gr</b>

**250 + 250 Wh EVO BOTTLE BATTERY**  
+ POWER BANK USB





# Polini E-P3+EVO

## POLINI E-P3+ POTENTE, COMPATTO, LEGGERO

Polini Motori rivoluziona il concetto di pedalata assistita e presenta il motore Polini E-P3+ per e-bike. Un motore innovativo, di nuova generazione, con il segno + (PLUS) a indicare le novità e l'importante passo in avanti realizzato grazie alla continua analisi, l'attento studio e l'impegno nella progettazione, sempre alla ricerca delle migliori performance. Leggero, potente e compatto il motore Polini E-P3+ ha un ingombro laterale tra i più ridotti della categoria ed eroga una coppia di 80Nm nella versione E-P3+ (Road) e 90 Nm nel modello MX (specifico per MTB) per i clienti più esigenti.

## POLINI E-P3+, POWERFUL, COMPACT, LIGHT

Polini Motori revolutionizes the concept of pedal-assist and presents the new Polini E-P3+ motor for e-bikes. An innovative and last generation motor, with the "+" sign (PLUS) to underline the novelties and the important step forward thanks to the never-ending analysis, the study and commitment in designing it, always looking for better performance. Light, powerful and compact, Polini E-P3+ motor features a very reduced volume and it exploits a 75Nm torque in the E-P3+ (ROAD) and 90 Nm in the MX model (for MTB) for the most demanding users.

### AUTONOMIA | RANGE

LIVELLO ASSISTENZA ASSISTANCE LEVEL	AIUTO ASSISTENZA ASSISTANCE	AUTONOMIA RANGE 500 kw	AUTONOMIA RANGE 1000 kw
1	30%	180-220 km	340-420 km
2	60%	150-180 km	280-340 km
3	120%	100-150 km	180-280 km
4	250%	80-100 km	140-180 km
5	400%	60-85 km	100-150 km



#### E-P3+ GP

<b>Potenza</b>	250 Watt (500 Watt di picco)
<b>Peso</b>	2.950 gr.
<b>Coppia massima</b>	80 Nm
<b>Assistenza</b>	25 km/h
<b>Grado di protezione</b>	IP 55
<b>Frequenza pedalata</b>	max 120



#### E-P3+ MX EVO

<b>Potenza</b>	250 Watt (600 Watt di picco)
<b>Peso</b>	2.950 gr.
<b>Coppia massima</b>	90 Nm
<b>Assistenza</b>	25 km/h
<b>Grado di protezione</b>	IP 55
<b>Frequenza pedalata</b>	max 120



Il nuovo motore EP3+ presenta un nuovo firmware che abilita e permette di gestire tutte le migliorie inserite nel nuovo hardware. Il lavoro del nuovo software di controllo è stato studiato e sviluppato per potenziare la pedalata, rendendola reattiva e naturale, porgendo molta attenzione ai consumi.

The new EP3+ engine features a new firmware that enables and allows you to manage all the improvements included in the new hardware. The work of the new control software has been studied and developed to enhance pedaling, making it reactive and natural, paying close attention to consumption.

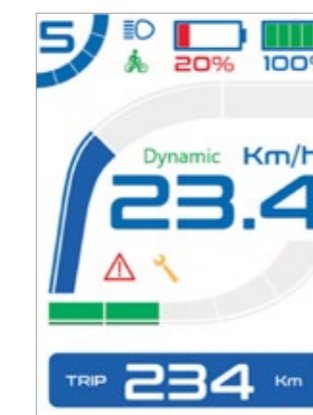





# Project Ciocc

Personalizza la tua bici e progetta ogni dettaglio: il nostro team di artisti e artigiani la porterà in vita. L'unico limite è la tua immaginazione.



[www.ciocc.it/configuratore](http://www.ciocc.it/configuratore)

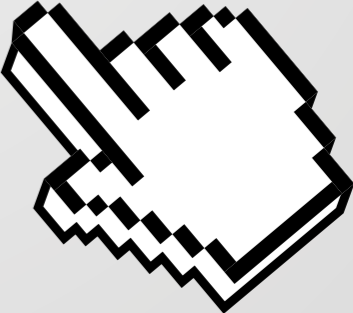





[www.ciocc.it](http://www.ciocc.it)

Prodotto e Distribuito da  
**ITALIAN STYLE BICYCLES srl**  
Via Bergamo, 24 - 24035 Curno - BG / IT  
T. +39 035 451 7248